

Price List **2023-24**

[www.akssteel.com](http://www.akssteel.com)



**अक्स**

## Door & Window Fittings

At aks, we just can't afford to lose sight of precision in our products. After all, door and window fittings must have the ability to last long, stay strong and be smooth and precise at all times. From hinges, tower bolts, door stoppers to handles, we manufacture seamlessly with in-depth research to bring you artistically designed products. Explore the tried, tested and trusted solutions today.

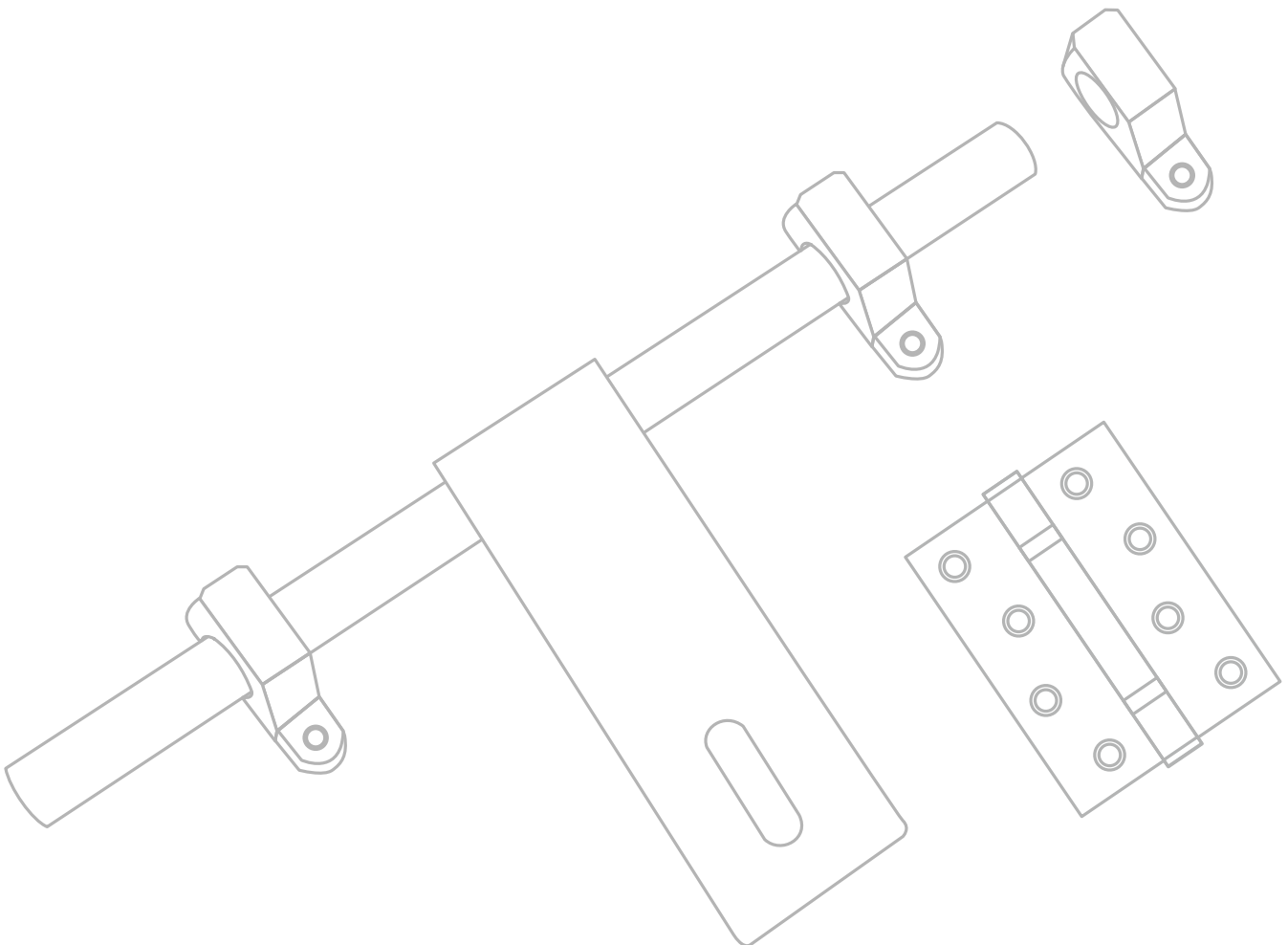
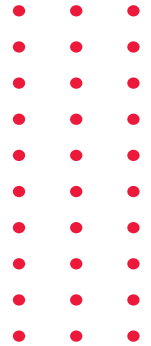



# Outstanding Technology

Our manufacturing processes bear the highest markers of quality and performance.

## Our Vision

To make life better by crafting innovative and smart solutions

## Our Mission

To create a diverse range of smartly-designed and smoothly-functional solutions of high quality for our consumers.

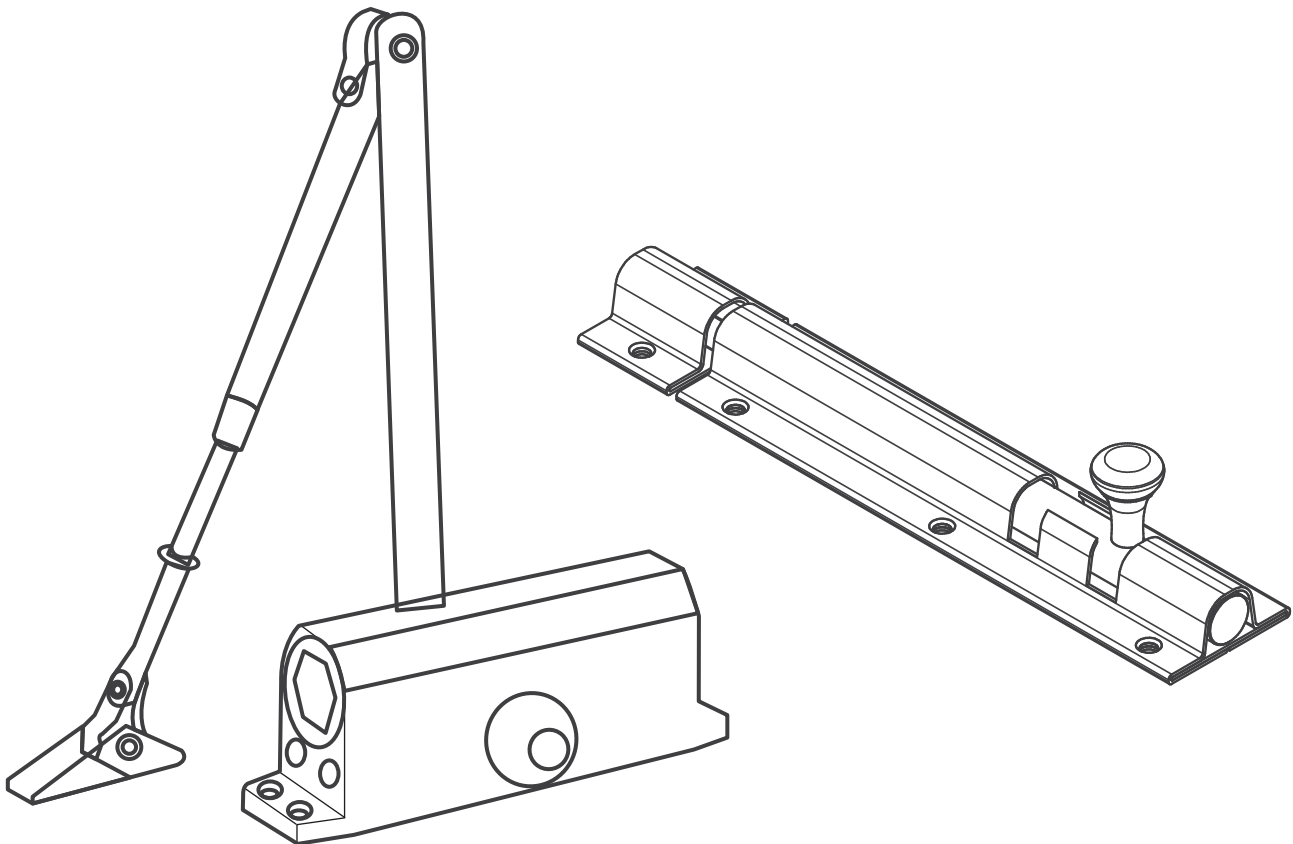

*Customer Satisfaction*

*High Quality*

*Diverse Product Range*

*Smart Designs*

## Signature Series 06-28

Hinges	06-08
Tower Bolt & Baby Latch	09-13
Al-Drop & Latch	14-16
Door Stopper	17
Rose Pull Handles	19
Pull Handle	20
Window Pull handle	21-22
Cabinet Handle & Drawer Knob	23-25
Gate Hook	26-27
Door Closer	28

## Platinum Series 29-35

Hinges	29
Tower Bolt & Baby Latch	30
Door Accessories	31
Al-Drop & Latch	32
Rose Pull Handles	33
Pull handle	34-35

## Emerald Series 36-63

Hinges	36-39
Tower Bolt & Baby Latch	40-45
Door Accessories	46
Al-Drop & Latch	47-50
Pull Handle	51-52
Window Pull Handle	53-54
Door Closer	55-57
Screw	58-61
Hook	62

## Door & Window Fittings

Runs Smoothly. Fit Precisely



Strong Support  
Easy Rotation

**Available Finish**

- MSL-Matt Satin Lacquered | ● MB-Matt Black | ● RG.PVD - Rose Gold PVD
- AB-Antique Brass | ● AC-Antique Copper | ● MAB-Matt Antique Brass
- SBRG-Scotch Brite Rose Gold | ● GD.PVD-Gold PVD

### Four Ball Bearing Hinges

Size	Pcs./Case	MSL Price/Pc.	AB/AC Price/Pc.	MB/MAB /SBRG Price/Pc.	RG.PVD/ GD.PVD Price/Pc.
4" x 3" x 3.00	80	340/-	370/-	380/-	440/-
5" x 3" x 3.00	60	400/-	430/-	450/-	520/-
6" x 3" x 3.00	40	460/-	500/-	520/-	600/-

**Available Finish**

- MSL-Matt Satin Lacquered | ● MB-Matt Black
- AB-Antique Brass | ● AC-Antique Copper | ● MAB-Matt Antique Brass
- SBRG-Scotch Brite Rose Gold

### Double Ball Bearing Hinges

Size	Pcs./Case	MSL Price/Pc.	AB/AC Price/Pc.	MAB/MB/SBRG Price/Pc.
3" x 2.50" x 2.50	120	220/-	240/-	250/-
4" x 3.00" x 2.50	80	280/-	310/-	320/-
5" x 3.00" x 2.50	60	320/-	360/-	380/-
4" x 3.00" x 3.00	80	320/-	350/-	360/-
5" x 3.00" x 3.00	60	370/-	410/-	420/-
4" x 3.50" x 3.00	60	370/-	400/-	420/-
5" x 3.50" x 3.00	60	440/-	480/-	500/-
4" x 4.00" x 3.00	60	450/-	490/-	510/-



**Available Finish**

- MSL-Matt Satin Lacquered | ● MB-Matt Black
- AC-Antique Copper | ● AB-Antique Brass
- MAB-Matt Antique Brass | ● SBRG-Scotch Brite Rose Gold

### Parliament Moon Type Hinges

Size	Pcs./Case	MSL Price/Pc.	AB/AC Price/Pc.	MAB/MB/SBRG Price/Pc.
(3") 4" x 5" x 3.00	60	400/-	440/-	460/-
(4") 4" x 6" x 3.00	60	440/-	490/-	510/-
(5") 4" x 7" x 3.00	40	500/-	550/-	580/-
(6") 4" x 8" x 3.00	40	550/-	620/-	650/-



**Available Finish**

- MSL-Matt Satin Lacquered | ● MB-Matt Black
- AC-Antique Copper | ● AB-Antique Brass
- MAB-Matt Antique Brass | ● SBRG-Scotch Brite Rose Gold

### Flush Hinges (Double Ball Bearing)

Size	Pcs./Case	MSL Price/Pc.	AB/AC Price/Pc.	MAB/MB/SBRG Price/Pc.
4" x 3" x 2.5mm	80	250/-	270/-	280/-
5" x 3" x 3.0mm	60	310/-	340/-	350/-



**Available Finish**

- MSL-Matt Satin Lacquered | ● MB-Matt Black | ● RG.PVD - Rose Gold PVD
- AB-Antique Brass | ● AC-Antique Copper | ● MAB-Matt Antique Brass
- SBRG-Scotch Brite Rose Gold | ● GD.PVD-Gold PVD

### Seamless Butt / Granite Hinges

Size	Pcs./Case	MSL Price/Pc.	AB/AC Price/Pc.	MAB/MB/SBRG Price/Pc.	(Pin Hinge) RG.PVD/GD. PVD Price/Pc.
3" x 1.00" x 2.50 (Reg.)	120	116/-	130/-	138/-	-
3" x 1.00" x 2.50 (Wide)	120	142/-	158/-	166/-	-
4" x 1.00" x 2.50	120	176/-	196/-	206/-	-
5" x 1.00" x 2.50	80	220/-	240/-	256/-	-
6" x 1.00" x 2.50	60	284/-	314/-	330/-	-
4" x 1.00" x 3.00	80	230/-	250/-	260/-	320/-
5" x 1.00" x 3.00	60	270/-	300/-	300/-	400/-
4" x 1.25" x 3.00 (H)	80	270/-	300/-	310/-	390/-
5" x 1.25" x 3.00 (H)	60	330/-	360/-	370/-	450/-
6" x 1.25" x 3.00 (H)	40	400/-	440/-	460/-	540/-
4" x 1.50" x 3.00	60	340/-	370/-	380/-	460/-
5" x 1.50" x 3.00	60	410/-	440/-	460/-	540/-
6" x 1.50" x 3.00	40	480/-	520/-	540/-	620/-
8" x 1.50" x 3.00	40	650/-	710/-	740/-	850/-



**Available Finish**

- MSL-Matt Satin Lacquered | ● MB-Matt Black
- AC-Antique Copper | ● AB-Antique Brass
- MAB-Matt Antique Brass | ● SBRG-Scotch Brite Rose Gold

### Opera Tower-Bolt

Size	Pcs./Case	MSL Price/Pc.	AB/AC Price/Pc.	MB/MAB/SBRG Price/Pc.
4" x 12	80	320/-	352/-	360/-
6" x 12	60	420/-	468/-	480/-
8" x 12	40	560/-	624/-	640/-
12" x 12	30	840/-	936/-	960/-
18" x 12	20	1260/-	1404/-	1440/-
24" x 12	20	1680/-	1872/-	1920/-



**Available Finish**

- MSL-Matt Satin Lacquered | ● BSL-Black Satin Lacquered
- BAB-Black Antique Brass | ● MAB-Matt Antique Brass
- MB-Matt Black | ● SBRG-Scotch Brite Rose Gold

### Section Square Tower Bolt

Size	Pcs./Case	MSL Price/Pc.	BSL/BAB Price/Pc.	MB/MAB/SBRG Price/Pc.
6" x 13	60	372/-	408/-	420/-
8" x 13	40	496/-	544/-	560/-
12" x 13	30	744/-	816/-	840/-
18" x 13	20	1116/-	1224/-	1260/-
24" x 13	20	1488/-	1632/-	1680/-
36" x 13	10	2232/-	2448/-	2520/-
4" x 12	120	240/-	264/-	272/-
6" x 12	80	348/-	384/-	396/-
8" x 12	60	464/-	512/-	528/-
10" x 12	50	580/-	640/-	660/-
12" x 12	40	696/-	768/-	792/-
18" x 12	30	1044/-	1152/-	1188/-
24" x 12	20	1392/-	1536/-	1584/-



**Available Finish**

- MSL-Matt Satin Lacquered | ● MB-Matt Black | ● RG.PVD - Rose Gold PVD
- AB-Antique Brass | ● AC-Antique Copper | ● MAB-Matt Antique Brass
- SBRG-Scotch Brite Rose Gold | ● GD.PVD-Gold PVD

### Section Round Tower Bolt

Size	Pcs./Case	MSL Price/Pc.	AB/AC Price/Pc.	MB/MAB/SBRG Price/Pc.	RG.PVD/ GD. PVD Price/Pc.
4" x 12	120	240/-	264/-	272/-	340/-
6" x 12	80	348/-	384/-	396/-	468/-
8" x 12	60	464/-	512/-	528/-	624/-
10" x 12	50	580/-	640/-	660/-	780/-
12" x 12	40	696/-	768/-	792/-	936/-
18" x 12	30	1044/-	1152/-	1188/-	1404/-
24" x 12	20	1392/-	1536/-	1584/-	1872/-
4" x 10	120	200/-	224/-	-	-
6" x 10	80	288/-	324/-	-	-
8" x 10	60	384/-	432/-	-	-
10" x 10	50	480/-	540/-	-	-
12" x 10	40	576/-	648/-	-	-
18" x 10	30	864/-	972/-	-	-



**Available Finish**

- MSL-Matt Satin Lacquered | ● MB-Matt Black
- AC-Antique Copper | ● AB-Antique Brass
- MAB-Matt Antique Brass | ● SBRG-Scotch Brite Rose Gold

### Xylo Tower Bolt

Size	Pcs./Case	SL Price/Pc.	AB/AC Price/Pc.	MB/SBRG Price/Pc.
4" x 10	240	136/-	160/-	168/-
6" x 10	180	192/-	228/-	240/-
8" x 10	120	256/-	304/-	320/-
10" x 10	60	320/-	380/-	400/-
12" x 10	60	384/-	456/-	480/-
18" x 10	30	576/-	684/-	720/-
24" x 10	30	768/-	912/-	960/-

# » Tower Bolt

## SIGNATURE SERIES



**Available Finish**

- MSL-Matt Satin Lacquered | ● MB-Matt Black
- AC-Antique Copper | ● AB-Antique Brass
- MAB-Matt Antique Brass | ● SBRG-Scotch Brite Rose Gold

## Regal Tower Bolt

Size	Pcs./Case	SL Price/Pc.	AB/AC Price/Pc.	MB/SBRG Price/Pc.
4" x 10	240	128/-	152/-	160/-
6" x 10	180	180/-	216/-	228/-
8" x 10	120	240/-	288/-	304/-
10" x 10	60	300/-	360/-	380/-
12" x 10	60	360/-	432/-	456/-
18" x 10	30	540/-	648/-	684/-
24" x 10	30	720/-	864/-	816/-



**Available Finish**

- MSL-Matt Satin Lacquered | ● MB-Matt Black
- AC-Antique Copper | ● AB-Antique Brass
- MAB-Matt Antique Brass | ● SBRG-Scotch Brite Rose Gold

## Royal Tower Bolt

Size	Pcs./Case	SL Price/Pc.	AB/AC Price/Pc.	MB/SBRG Price/Pc.
4" x 10	240	128/-	152/-	160/-
6" x 10	180	180/-	216/-	228/-
8" x 10	120	240/-	288/-	304/-
10" x 10	60	300/-	360/-	380/-
12" x 10	60	360/-	432/-	456/-
18" x 10	30	540/-	648/-	684/-
24" x 10	30	720/-	864/-	816/-



**Available Finish** | ● MSL-Matt Satin Lacquered | ● MB-Matt Black | ● RG.PVD - Rose Gold PVD  
 ● AB-Antique Brass | ● AC-Antique Copper | ● MAB-Matt Antique Brass  
 ● GD.PVD-Gold PVD

Combo Sleek Al-Drop

Size	Pcs./Case	MSL Price/Pc.	AB/AC Price/Pc.	MB/MAB Price/Pc.	RG.PVD/ GD. PVD Price/Pc.
8" (2+1)	30	780/-	880/-	930/-	1040/-
10" (3+1)	30	890/-	1010/-	1070/-	1190/-
12" (3+1)	30	940/-	1060/-	1120/-	1240/-
14" (4+1)	20	1080/-	1220/-	1290/-	1420/-



### Lamont Al-Drop

Size	Pcs./Case	MSL Price/Pc.	AB/AC Price/Pc.
14" (3+1)	10	1460/-	1580/-
18" (4+1)	10	1720/-	1860/-

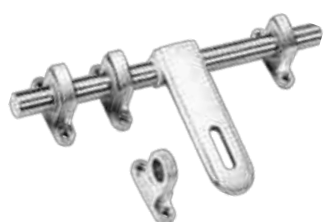

### Casting Straight Al-Drop

Size	Pcs./Case	MSL Price/Pc.	AB/AC Price/Pc.
8" (2+1)	30	820/-	920/-
10" (3+1)	30	930/-	1050/-
12" (3+1)	30	980/-	1100/-



### Creta Al-Drop

Size	Pcs./Case	MSL Price/Pc.	AB/AC Price/Pc.
8" (3+1)	30	760/-	860/-
10" (3+1)	30	900/-	1020/-
12" (4+1)	30	950/-	1070/-



### Auro Al-Drop

Size	Pcs./Case	MSL Price/Pc.	MB/MAB Price/Pc.	RG.PVD/ GD. PVD Price/Pc.
8" (2+1)	30	780/-	930/-	1080/-
10" (3+1)	30	890/-	1070/-	1250/-
12" (3+1)	30	940/-	1120/-	1300/-

**Available Finish** | ● MSL-Matt Satin Lacquered | ● MB-Matt Black | ● RG.PVD - Rose Gold PVD  
 ● AB-Antique Brass | ● AC-Antique Copper | ● MAB-Matt Antique Brass | ● GD.PVD-Gold PVD



**Available Finish** | ● MSL-Matt Satin Lacquered | ● MB-Matt Black | ● RG.PVD - Rose Gold PVD  
● AB-Antique Brass | ● AC-Antique Copper | ● MAB-Matt Antique Brass

### Sleek Combo Latch

Size	Pcs./Case	MSL Price/Pc.	AB/AC Price/Pc.	MB/MAB Price/Pc.	RG.PVD/ GD. PVD Price/Pc.
8"	40	440/-	540/-	590/-	740/-
10"	40	460/-	560/-	610/-	760/-
12"	40	480/-	580/-	630/-	780/-



**Available Finish** | ● MSL-Matt Satin Lacquered | ● BSL-Black Satin Lacquered  
● BAB-Black Antique Brass | ● SBRG-Scotch Brite Rose Gold  
● MB-Matt Black | ● GD.PVD-Gold PVD | ● RG.PVD - Rose Gold PVD

### Duster Baby Latch

Size	Pcs./Case	MSL Price/Pc.	BSL/BAB Price/Pc.	MAB/MB/SBRG Price/Pc.	RG.PVD/ GD. PVD Price/Pc.
3"	60	270/-	300/-	310/-	380/-

# » Door Stopper & Silencer

SIGNATURE SERIES



**Available Finish**

- MSL-Matt Satin Lacquered
- MB-Matt Black
- RG.PVD - Rose Gold PVD
- AB-Antique Brass
- AC-Antique Copper
- MAB-Matt Antique Brass
- SBRG-Scotch Brite Rose Gold
- GD.PVD-Gold PVD

## Ajanta Door Stopper

Size	Pcs./Case	MSL Price/Pc.	AB/AC Price/Pc.	MB/MAB/ SBRG Price/Pc.	RG.PVD/ GD. PVD Price/Pc.
5"	60	450/-	480/-	490/-	540/-



**Available Finish**

- MSL-Matt Satin Lacquered
- MB-Matt Black
- RG.PVD - Rose Gold PVD
- AB-Antique Brass
- AC-Antique Copper
- MAB-Matt Antique Brass
- SBRG-Scotch Brite Rose Gold
- GD.PVD-Gold PVD

## Eva Door Silencer

Size	Pcs./Case	MSL Price/Pc.	AB/AC Price/Pc.	MB/MAB/ SBRG Price/Pc.	RG.PVD/ GD. PVD Price/Pc.
3"	60	220/-	250/-	260/-	310/-

Effortlessly  
Stylish



# » Rose Pull Handles

## SIGNATURE SERIES

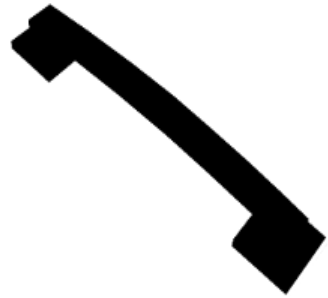

### Fortuner

Size	Pair/Case	MSL Price/Pc.	AB/AC Price/Pc.	MB/MAB/ SBRG Price/Pc.	RG.PVD/ GD. PVD Price/Pc.
200x260	20	1300/-	1360/-	1420/-	1580/-
250x310	20	1360/-	1440/-	1500/-	1640/-
300x360	20	1420/-	1520/-	1580/-	1700/-



### Decent

Size	Pair/Case	MSL Price/Pc.	AB/AC Price/Pc.	MB/MAB/ SBRG Price/Pc.	RG.PVD/ GD. PVD Price/Pc.
200x258	20	1360/-	1420/-	1480/-	1640/-
250x308	20	1420/-	1500/-	1560/-	1700/-
300x358	20	1480/-	1580/-	1640/-	1760/-

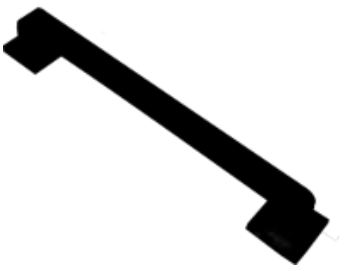

### Avalone

Size	Pair/Case	MSL Price/Pc.	AB/AC Price/Pc.	MB/MAB/ SBRG Price/Pc.	RG.PVD/ GD. PVD Price/Pc.
200x255	20	1240/-	1300/-	1360/-	1520/-
250x305	20	1300/-	1380/-	1440/-	1580/-
300x355	20	1360/-	1460/-	1520/-	1640/-



### Lado

Size	Pair/Case	MSL Price/Pc.	AB/AC Price/Pc.	MB/MAB/ SBRG Price/Pc.	RG.PVD/ GD. PVD Price/Pc.
200 x 255	20	1300/-	1360/-	1420/-	1580/-
250 x 305	20	1360/-	1440/-	1500/-	1640/-
300 x 355	20	1420/-	1520/-	1580/-	1700/-



### Eitos

Size	Pair/Case	MSL Price/Pc.	AB/AC Price/Pc.	MB/MAB/ SBRG Price/Pc.	RG.PVD/ GD. PVD Price/Pc.
200 x 251	20	1300/-	1360/-	1460/-	1580/-
250 x 301	20	1360/-	1440/-	1540/-	1640/-
300 x 351	20	1420/-	1520/-	1620/-	1700/-

**Available Finish** | ● MSL-Matt Satin Lacquered | ● MB-Matt Black | ● RG.PVD - Rose Gold PVD | ● AB-Antique Brass  
● AC-Antique Copper | ● MAB-Matt Antique Brass | ● SBRG-Scotch Brite Rose Gold | ● GD.PVD-Gold PVD

# » Pull Handles

## SIGNATURE SERIES



### Accent

Size	Pair/Case	SL/MSL Price/Pc.	AB/AC Price/Pc.	MB/MAB/ SBRG Price/Pc.	RG.PVD/ GD. PVD Price/Pc.
200x300	20	2160/-	2260/-	2320/-	2560/-
250x350	20	2280/-	2400/-	2460/-	2680/-
300x450	20	2540/-	2680/-	2760/-	2940/-



### Fortuner

Size	Pair/Case	SL/MSL Price/Pc.	AB/AC Price/Pc.	MB/MAB/ SBRG Price/Pc.	RG.PVD/ GD. PVD Price/Pc.
200x230	20	2140/-	2200/-	2260/-	2540/-
250x280	20	2260/-	2340/-	2400/-	2660/-
300x330	20	2380/-	2480/-	2540/-	2780/-

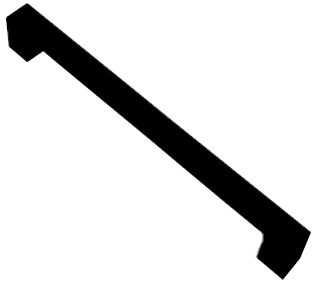

### Decent

Size	Pair/Case	SL/MSL Price/Pc.	AB/AC Price/Pc.	MB/MAB/ SBRG Price/Pc.	RG.PVD/ GD. PVD Price/Pc.
200x228	20	2260/-	2320/-	2380/-	2660/-
250x278	20	2380/-	2460/-	2520/-	2780/-
300x328	20	2500/-	2600/-	2660/-	2900/-



### Avalone

Size	Pair/Case	SL/MSL Price/Pc.	AB/AC Price/Pc.	MB/MAB/ SBRG Price/Pc.	RG.PVD/ GD. PVD Price/Pc.
200x225	20	2020/-	2080/-	2140/-	2420/-
250x275	20	2140/-	2220/-	2280/-	2540/-
300x325	20	2260/-	2360/-	2420/-	2660/-



### Lado

Size	Pair/Case	SL/MSL Price/Pc.	AB/AC Price/Pc.	MB/MAB/ SBRG Price/Pc.	RG.PVD/ GD. PVD Price/Pc.
200x225	20	2080/-	2100/-	2200/-	2480/-
250x275	20	2220/-	2280/-	2340/-	2620/-
300x325	20	2320/-	2420/-	2480/-	2720/-

**Available Finish** | ● MSL-Matt Satin Lacquered | ● MB-Matt Black | ● RG.PVD - Rose Gold PVD | ● AB-Antique Brass  
● AC-Antique Copper | ● MAB-Matt Antique Brass | ● SBRG-Scotch Brite Rose Gold | ● GD.PVD-Gold PVD



**Available Finish**

- MSL-Matt Satin Lacquered | ● MB-Matt Black | ● RG.PVD - Rose Gold PVD
- AB-Antique Brass | ● AC-Antique Copper | ● MAB-Matt Antique Brass
- SBRG-Scotch Brite Rose Gold | ● GD.PVD-Gold PVD

### Bentley Handle

Size	Pcs./Case	MSL Price/Pc.	AB/AC Price/Pc.	MB/MAB/SBRG Price/Pc.	RG.PVD/GD. PVD Price/Pc.
5" x 4.00	120	200/-	210/-	220/-	280/-
6" x 4.00	60	220/-	230/-	250/-	310/-
8" x 4.00	60	250/-	260/-	280/-	340/-



**Available Finish**

- MSL-Matt Satin Lacquered | ● MB-Matt Black | ● RG.PVD - Rose Gold PVD
- AB-Antique Brass | ● AC-Antique Copper | ● MAB-Matt Antique Brass
- SBRG-Scotch Brite Rose Gold | ● GD.PVD-Gold PVD

### Kwid Handle

Size	Pcs./Case	MSL Price/Pc.	AB/AC Price/Pc.	MB/MAB/SBRG Price/Pc.	RG.PVD/GD. PVD Price/Pc.
6" x 4.00	60	214/-	230/-	246/-	290/-
8" x 4.00	60	234/-	250/-	266/-	310/-



**Available Finish**

- MSL-Matt Satin Lacquered
- MB-Matt Black
- RG.PVD - Rose Gold PVD
- AB-Antique Brass
- AC-Antique Copper
- MAB-Matt Antique Brass
- SBRG-Scotch Brite Rose Gold
- GD.PVD-Gold PVD

### A-One Handle

Size	Pcs./Case	MSL Price/Pc.	AB/AC Price/Pc.	MB/MAB/SBRG Price/Pc.	RG.PVD/GD. PVD Price/Pc.
5" x 3.00	80	98/-	110/-	122/-	170/-
6" x 3.00	80	108/-	120/-	132/-	180/-



**Available Finish**

- MSL-Matt Satin Lacquered
- MB-Matt Black
- RG.PVD - Rose Gold PVD
- AB-Antique Brass
- AC-Antique Copper
- MAB-Matt Antique Brass
- SBRG-Scotch Brite Rose Gold
- GD.PVD-Gold PVD

### A-Two Handle

Size	Pcs./Case	MSL Price/Pc.	AB/AC Price/Pc.	MB/MAB/SBRG Price/Pc.	RG.PVD/GD. PVD Price/Pc.
5" x 4.00	80	138/-	150/-	162/-	186/-
6" x 4.00	60	158/-	170/-	182/-	206/-
8" x 4.00	60	194/-	210/-	218/-	242/-

# » Cabinet Handles

## SIGNATURE SERIES

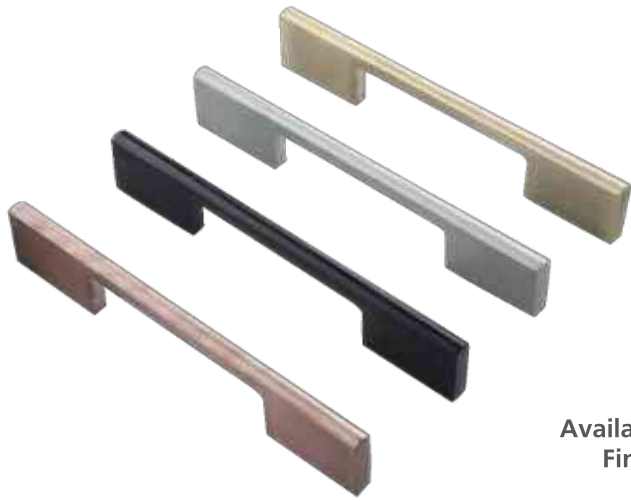

### Available Finish

- MSL-Matt Satin Lacquered | ● MB-Matt Black | ● RG.PVD - Rose Gold PVD
- AB-Antique Brass | ● AC-Antique Copper | ● MAB-Matt Antique Brass
- SBRG-Scotch Brite Rose Gold | ● GD.PVD-Gold PVD

## Optima

Size	Pcs./Case	MSL Price/Pc.	AB/AC Price/Pc.	MB/MAB/SBRG Price/Pc.	RG.PVD/GD. PVD Price/Pc.
96x128	180	230/-	250/-	290/-	350/-
128x171	180	280/-	300/-	340/-	400/-
160x213	90	330/-	350/-	390/-	450/-
192x256	90	380/-	400/-	440/-	500/-
256x341	60	440/-	470/-	530/-	630/-
320x427	45	530/-	570/-	650/-	770/-



### Available Finish

- MSL-Matt Satin Lacquered | ● MB-Matt Black | ● RG.PVD - Rose Gold PVD
- AB-Antique Brass | ● AC-Antique Copper | ● MAB-Matt Antique Brass
- SBRG-Scotch Brite Rose Gold | ● GD.PVD-Gold PVD

## Liva Square

Size	Pcs./Case	MSL Price/Pc.	AB/AC Price/Pc.	MB/MAB Price/Pc.	RG.PVD/GD. PVD Price/Pc.
96x118	144	240/-	260/-	310/-	370/-
128x150	144	260/-	280/-	340/-	400/-
160x185	108	300/-	320/-	390/-	450/-
192x217	108	330/-	350/-	420/-	480/-
256x291	72	420/-	450/-	490/-	610/-
320x355	72	470/-	500/-	540/-	660/-

### Polo (Ss304)



Size	Pcs./Case	SL Price/Pc.	AB/AC Price/Pc.	MAB/MB Price/Pc.	RG.PVD/ GD. PVD Price/Pc.
128 x 141	120	420/-	440/-	490/-	550/-
160 x 173	120	440/-	460/-	520/-	580/-
192 x 205	120	460/-	480/-	550/-	610/-
256 x 269	80	510/-	540/-	590/-	690/-
320 x 333	80	560/-	580/-	630/-	750/-

### Monza (Ss304)



Size	Pcs./Case	SL Price/Pc.	AB/AC Price/Pc.	MAB/MB Price/Pc.	RG.PVD/ GD. PVD Price/Pc.
96 x 106	120	360/-	380/-	430/-	490/-
128 x 138	120	380/-	400/-	460/-	520/-
160 x 170	120	400/-	420/-	490/-	550/-
192 x 202	120	420/-	440/-	510/-	570/-
256 x 268	80	480/-	510/-	550/-	670/-
320 x 330	80	520/-	550/-	690/-	710/-

### Ch-327



Size	Pcs./Case	MSL Price/Pc.	AB/AC Price/Pc.	MAB/MB Price/Pc.	RG.PVD/ GD. PVD Price/Pc.
160 x 200	120	360/-	380/-	440/-	500/-
192 x 264	90	420/-	440/-	510/-	570/-
224 x 328	60	480/-	500/-	570/-	630/-
256 x 392	60	550/-	580/-	630/-	730/-
288 x 456	60	640/-	680/-	710/-	830/-
320 x 520	60	720/-	760/-	790/-	910/-

**Available Finish** | ● MSL-Matt Satin Lacquered | ● MB-Matt Black | ● RG.PVD - Rose Gold PVD  
 ● AB-Antique Brass | ● AC-Antique Copper | ● MAB-Matt Antique Brass | ● GD.PVD-Gold PVD

# » Drawer Knob

## SIGNATURE SERIES

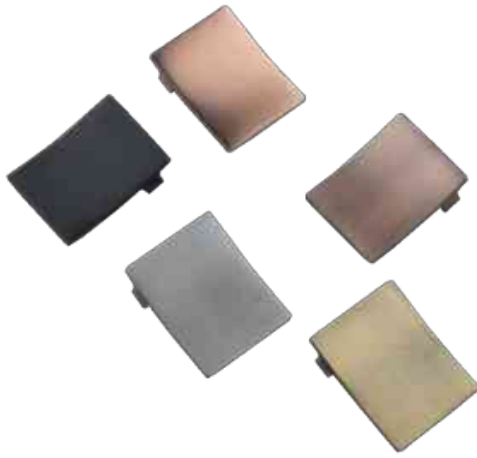

**Available Finish**

- MSL-Matt Satin Lacquered | ● MB-Matt Black | ● RG.PVD - Rose Gold PVD
- AB-Antique Brass | ● AC-Antique Copper | ● MAB-Matt Antique Brass
- GD.PVD-Gold PVD

### DK-1101

Design	Pcs./Box	Box/Case	Pcs./Case	MSL Price/Pc.	AB/AC Price/Pc.	MAB/MB Price/Pc.	RG.PVD/ GD. PVD Price/Pc.
DK-1101	24	6	144	72/-	90/-	96/-	110/-



**Available Finish**

- MSL-Matt Satin Lacquered | ● MB-Matt Black | ● RG.PVD - Rose Gold PVD
- AB-Antique Brass | ● AC-Antique Copper | ● MAB-Matt Antique Brass
- GD.PVD-Gold PVD

### DK-1103

Design	Pcs./Box	Box/Case	Pcs./Case	MSL Price/Pc.	AB/AC Price/Pc.	MAB/MB Price/Pc.	RG.PVD/ GD. PVD Price/Pc.
DK-1103	16	6	96	72/-	90/-	96/-	110/-



### DK-1102

Design	Pcs./Box	Box/Case	Pcs./Case	MSL Price/Pc.	AB/AC Price/Pc.	MAB/MB Price/Pc.
DK-1102	16	6	96	60/-	78/-	84/-



### DK-1104

Design	Pcs./Box	Box/Case	Pcs./Case	MSL Price/Pc.	AB/AC Price/Pc.	MAB/MB Price/Pc.
DK-1105	16	6	96	84/-	102/-	108/-

# » Cloth Hooks

SIGNATURE SERIES

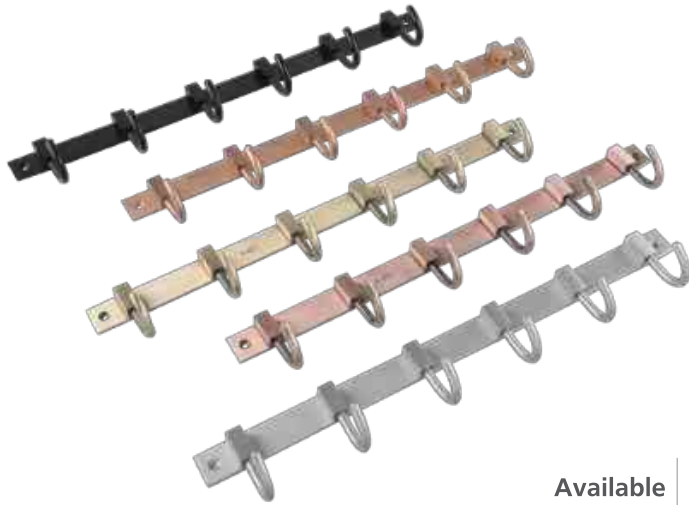

**Available Finish**

- MSL-Matt Satin Lacquered | ● MB-Matt Black | ● RG.PVD - Rose Gold PVD
- AB-Antique Brass | ● AC-Antique Copper | ● MAB-Matt Antique Brass
- SBRG-Scotch Brite Rose Gold | ● GD.PVD-Gold PVD

## Cube Cloth Hook

Size	Pcs./Case	MSL Price/Pc.	AB/AC Price/Pc.	MAB/MB Price/Pc.	RG.PVD/ GD. PVD Price/Pc.
1 STUD	240	150/-	210/-	230/-	270/-
2 STUD	180	260/-	320/-	340/-	380/-
3 STUD	120	340/-	420/-	440/-	480/-
4 STUD	90	420/-	500/-	540/-	620/-
5 STUD	60	500/-	600/-	650/-	750/-
6 STUD	60	590/-	690/-	740/-	840/-

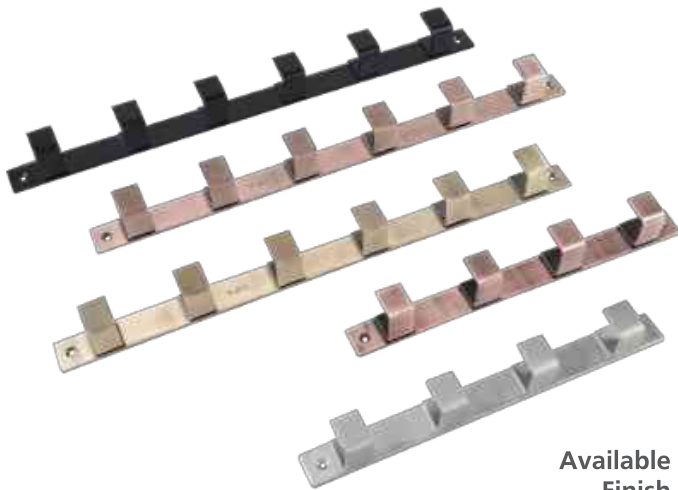

**Available Finish**

- MSL-Matt Satin Lacquered | ● MB-Matt Black | ● RG.PVD - Rose Gold PVD
- AB-Antique Brass | ● AC-Antique Copper | ● MAB-Matt Antique Brass
- SBRG-Scotch Brite Rose Gold | ● GD.PVD-Gold PVD

## Casa Cloth Hook

Size	Pcs./Case	MSL Price/Pc.	AB/AC Price/Pc.	MAB/MB Price/Pc.	RG.PVD/ GD. PVD Price/Pc.
3 STUD	120	220/-	280/-	300/-	340/-
4 STUD	120	260/-	320/-	340/-	380/-
5 STUD	90	300/-	380/-	400/-	440/-
6 STUD	90	350/-	430/-	450/-	490/-

# » Gate Hooks

SIGNATURE SERIES



**Available Finish** | ● MSL-Matt Satin Lacquered | ● AB-Antique Brass  
● SBRG-Scotch Brite Rose Gold | ● AC-Antique Copper

## Square Gate Hook

Size	Pcs./Case	MSL Price/Pc.	AB/AC Price/Pc.	MB/SBRG Price/Pc.
2.0" x 4mm	1200	64/-	76/-	82/-
2.5" x 4mm	1200	65/-	77/-	83/-
4.0" x 6mm	240	85/-	100/-	108/-
5.0" x 6mm	240	87/-	102/-	110/-
6.0" x 6mm	240	90/-	105/-	113/-
8.0" x 6mm	180	96/-	111/-	119/-



**Available Finish** | ● MSL-Matt Satin Lacquered | ● AB-Antique Brass  
● SBRG-Scotch Brite Rose Gold | ● AC-Antique Copper

## Round Gate Hook

Size	Pcs./Case	MSL Price/Pc.	AB/AC Price/Pc.	MB/SBRG Price/Pc.
2.0" x 4mm	1200	50/-	62/-	68/-
2.5" x 4mm	1200	52/-	64/-	70/-
4.0" x 6mm	240	75/-	87/-	93/-
5.0" x 6mm	240	78/-	90/-	96/-
6.0" x 6mm	240	83/-	98/-	106/-
8.0" x 6mm	180	90/-	105/-	113/-



### Specification

- Applicable to single door with the maximum door width of 1000mm.
- Precise sealed, preventing oil leakage, useful time is more than 500,000 times.
- High quality die-casting aluminium alloy, protected with two-layer bright paint.
- Two hydraulic press valves controlling two stage doors closing speed automatically 180° fully hydraulic control.
- Two stage speed adjustable, maximum opening degree is 180°
- Can be installed on right and left opening doors, no need to refit.
- Suitable for the door weight of 60-85 kg
- Standard color: Silver



### Door Closer ADC-83

Size	Pcs./Case	SL Price/Pc.	MB/MAB Price/Pc.	RG.PVD Price/Pc.
5"	10	1880/-	2520/-	2680/-

### Specification

- Applicable to single door with the maximum door width of 1000mm.
- Precise sealed, preventing oil leakage, useful time is more than 500,000 times.
- High quality die-casting aluminium alloy, protected with two-layer bright paint.
- Two hydraulic press valves controlling two stage doors closing speed automatically 180° fully hydraulic control.
- Two stage speed adjustable, maximum opening degree is 180°
- Can be installed on right and left opening doors, no need to refit.
- Suitable for the door weight of 60-85 kg
- Standard color: Silver



### Door Closer ADC-81

Size	Pcs./Case	SL Price/Pc.	AB Price/Pc.	MB Price/Pc.
5"	25	1260/-	1380/-	1500/-



### Four Ball Bearing Hinges

Size	Pcs./Box	Box/Case	Pcs./Case	SATIN Price/Pc.
4"x3"x3.00	10	16	160	420/-
5"x3"x3.00	10	12	120	490/-
6"x3"x3.00	10	8	80	560/-



### Double Ball Bearing Hinges

Size	Pcs./Box	Box/Case	Pcs./Case	SATIN Price/Pc.
3"x2.5"x2.50	20	12	240	250/-
4"x2.5"x2.50	10	24	240	310/-
4"x3"x2.50	10	16	160	330/-
5"x3"x2.50	10	12	120	390/-
4"x3"x3.00	10	16	160	380/-
5"x3"x3.00	10	12	120	450/-
4"x3.5"x3.00	10	12	120	440/-
5"x3.5"x3.00	10	8	80	520/-
4"x4"x3.00	10	8	80	540/-

**CE**  
2812  
BS EN 1935:2002

### Flush Hinge (Double Ball Bearing )



Size	Pcs./Box	Box/Case	Pcs./Case	SATIN Price/Pc.
4"x3"x2.50	10	16	160	290/-
5"x3"x3.00	10	16	160	380/-

### Supreme Heavy But hinges



Size	Pcs./Box	Box/Case	Pcs./Case	SATIN Price/Pc.
3"x1"x2.50	20	12	240	170/-
4"x1"x2.50	10	24	240	230/-
5"x1"x2.50	10	16	160	290/-
4"x1.25"x2.50	10	16	160	260/-
5"x1.25"x2.50	10	12	120	320/-
4"x1"x3.00	10	16	160	290/-
5"x1"x3.00	10	12	120	350/-
4"x1.25"x3.00	10	16	160	340/-
5"x1.25"x3.00	10	12	120	410/-
6"x1.25"x3.00	10	8	80	480/-

### Eva Tower-Bolt

Size	Pcs./Box	Box/Case	Pcs./Case	SATIN Price/Pc.
4"x12	10	20	200	268/-
6"x12	5	30	150	390/-
8"x12	5	20	100	520/-
10"x12	5	12	60	650/-
12"x12	5	12	60	780/-
18"x12	5	6	30	1170/-
4"x10	10	24	240	228/-
6"x10	5	36	180	330/-
8"x10	5	24	120	440/-
10"x10	5	12	60	550/-
12"x10	5	12	60	660/-
18"x10	5	6	30	990/-

Grade AISI-304 Stainless Steel



### Half Square Tower-Bolt

Size	Pcs./Box	Box/Case	Pcs./Case	SATIN Price/Pc.
4"x10	10	24	240	210/-
6"x10	5	36	180	300/-
8"x10	5	24	120	400/-
10"x10	5	18	90	500/-
12"x10	5	18	90	600/-



### Eva Door Stopper

Size	Pcs./Box	Box/Case	Pcs./Case	TT Price/Pc.
3"x10mm (Double Rod)	8	15	120	360/-
4"x12mm (Single Rod)	8	15	120	260/-





**Ajanta Door Stopper**

Size	Pcs./Box	Box/Case	Pcs./Case	SATIN Price/Pc.
5"	1	60	60	420/-



**Eva Door Silencer**

Size	Pcs./Box	Box/Case	Pcs./Case	SATIN Price/Pc.
3"	10	12	120	190/-



**Magnet Door Holder**

Size	Pcs./Box	Box/Case	Pcs./Case	SATIN Price/Pc.
3"	20	10	200	310/-

Grade AISI-304 Stainless Steel



**D Plain Handle**

Size	Pcs./Box	Box/Case	Pcs./Case	SATIN Price/Pc.
5" x 3.00	20	12	12	120/-
6" x 3.00	20	12	12	130/-

### Ajanta Al-Drop

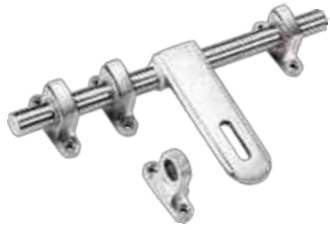

Size	Pcs./Box	Box/Case	Pcs./Case	SATIN Price/Pc.
8"x16mm (2+1)	1	30	30	1160/-
10"x16mm (3+1)	1	30	30	1300/-
12"x16mm (3+1)	1	30	30	1360/-
14"x16mm (4+1)	1	20	20	1500/-

### Alora Al-Drop

Grade AISI-304 Stainless Steel



Size	Pcs./Box	Box/Case	Pcs./Case	SATIN Price/Pc.
8"x16mm (2+1)	1	30	30	720/-
10"x16mm (3+1)	1	30	30	840/-
12"x16mm (3+1)	1	30	30	900/-
14"x16mm (4+1)	1	20	20	1080/-
8"x14mm (2+1)	4	10	40	560/-
10"x14mm (3+1)	4	10	40	660/-
12"x14mm (3+1)	4	10	40	700/-

### Alora Latch



Size	Pcs./Box	Box/Case	Pcs./Case	SATIN Price/Pc.
8"x (2+1)	4	20	80	380/-
10"x (3+1)	4	15	60	410/-
12" (3+1)	4	15	60	440/-



### Pacer

Size	Pcs./Box	Box/Case	Pcs./Case	SL Price/Pc.
200×258	1	20	20	1300/-
250×308	1	20	20	1360/-
300×358	1	20	20	1420/-



### Alfa

Size	Pcs./Box	Box/Case	Pcs./Case	SL Price/Pc.
200×258	1	20	20	1360/-
250×308	1	20	20	1420/-
300×358	1	20	20	1480/-



### Orbit

Size	Pcs./Box	Box/Case	Pcs./Case	SL Price/Pc.
200 × 260	1	40	40	1300/-
250 × 310	1	40	40	1360/-
300 × 360	1	40	40	1420/-

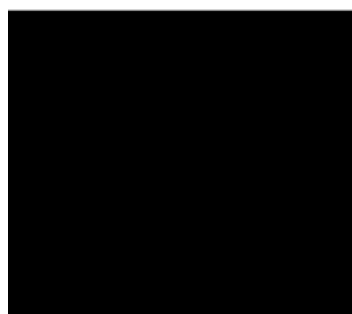

### Nikon

Size	Pcs./Box	Box/Case	Pcs./Case	SL Price/Pc.
200 × 251	1	20	20	1240/-
250 × 301	1	20	20	1300/-
300 × 351	1	20	20	1360/-

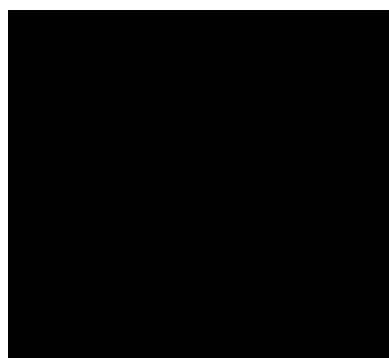

### Thunder

Size	Pcs./Box	Box/Case	Pcs./Case	SL Price/Pc.
200×300	1	20	20	1240/-
250×350	1	20	20	1300/-
300×450	1	20	20	1360/-



### Baleno

Size	Pcs./Box	Box/Case	Pair/Case	SL Price/Pair
200×225	1	20	20	2160/-
250×275	1	20	20	2280/-
300×325	1	20	20	2540/-



### Alfa

Size	Pcs./Box	Box/Case	Pair/Case	SL Price/Pair
200×228	1	20	20	2020/-
250×278	1	20	20	2140/-
300×328	1	20	20	2260/-



### Gema

Size	Pcs./Box	Box/Case	Pair/Case	SL Price/Pair
200×222	1	20	20	2260/-
250×272	1	20	20	2380/-
300×322	1	20	20	2500/-

1360/-

1420/-



### Nikon

Size	Pcs./Box	Box/Case	Pair/Case	SL Price/Pair
200×222	1	20	20	2160/-
250×272	1	20	20	2280/-
300×322	1	20	20	2540/-



### Dezire

Size	Pcs./Box	Box/Case	Pair/Case	SL Price/Pair
200×219	1	20	20	2080/-
250×269	1	20	20	2220/-
300×319	1	20	20	2320/-

Grade AISI-304 Stainless Steel





### Eco

Size	Pcs./Box	Box/Case	Pair/Case	SL Price/Pair
200x300	1	20	20	2140/-
250x350	1	20	20	2260/-
300x450	1	20	20	2380/-



IS : 17706



### Hexa

Size	Pcs./Box	Box/Case	Pair/Case	SL Price/Pair
200x300	1	20	20	2020/-
250x350	1	20	20	2140/-
300x450	1	20	20	2260/-

Grade AISI-304 Stainless Steel



### Four Ball Bearing Hinges

Size	Pcs./Box	Box/Case	Pcs./Case	SATIN Price/Pc.
4"x3"x3.00	10	16	160	310/-
5"x3"x3.00	10	12	120	360/-
6"x3"x3.00	10	8	80	420/-



### Double Ball Bearing Hinges

Size	Pcs./Box	Box/Case	Pcs./Case	SATIN Price/Pc.
3"x2.50"x2.50	20	12	240	200/-
4"x3"x2.50	10	16	160	250/-
5"x3"x2.50	10	12	120	290/-
4"x3"x3.00	10	16	160	290/-
5"x3"x3.00	10	12	120	340/-
4"x3.5"x3.00	10	12	120	330/-
5"x3.5"x3.00	10	8	80	400/-
4"x4"x3.00	10	8	80	410/-



### Flush Hinge (Double Ball Bearing )

Size	Pcs./Box	Box/Case	Pcs./Case	SATIN Price/Pc.
4"x3"x2.50	10	16	160	230/-
5"x3"x3.00	10	16	160	290/-



### Parliament Hinges (Moon Type )

Size	Pcs./Box	Box/Case	Pcs./Case	SATIN Price/Pc.
(3")4"x5"x3.00	8	10	80	360/-
(4")4"x6"x3.00	6	10	60	390/-
(5")4"x7"x3.00	6	10	60	440/-
(6")4"x8"x3.00	6	10	60	490/-

### Seamless Butt/Granite Hinges



Size	Pcs./Box	Box/Case	Pcs./Case	SATIN Price/Pc.
3"×1.8mm (3×15)	20	24	480	56/-
4"×1.9mm (4×14)	20	24	240	96/-
5"×1.9mm (5×14)	10	24	240	128/-
3"×1"×2.50 (3×12)	20	18	360	84/-
3"×1"×2.50 (Wide)	20	12	240	106/-
4"×1"×2.50 (4×12)	10	24	240	126/-
5"×1"×2.50 (5×12)	10	16	160	162/-
6"×1"×2.50 (6×12)	10	12	120	210/-
4"×1.25"×2.50	10	16	160	160/-
5"×1.25"×2.50	10	12	120	200/-
4"×1"×3.00	10	16	160	170/-
5"×1"×3.00	10	12	120	220/-
4"×1.25"×3.00 (H)	10	16	160	230/-
5"×1.25"×3.00 (H)	10	12	120	280/-
6"×1.25"×3.00 (H)	10	8	80	340/-
5"×1.25"×4.00 (SH)	8	10	80	360/-
4"×1.5"×3.00	10	8	80	260/-
5"×1.5"×3.00	10	8	80	320/-
6"×1.5"×3.00	10	8	80	380/-
8"×1.5"×3.00	10	6	60	510/-

### Rivited Butt Hinges



Size	Pcs./Box	Box/Case	Pcs./Case	SATIN Price/Pc.
3"×1.8mm (3×15)	20	24	480	48/-
4"×1.9mm (4×14)	10	24	240	86/-
5"×1.9mm (5×14)	10	24	240	116/-
3"×1"×2.5mm (3×12)	20	18	360	78/-
4"×1"×2.5mm (4×12)	10	24	240	114/-
5"×1"×2.5mm (5×12)	10	16	160	150/-
6"×1"×2.5mm (6×12)	10	12	120	196/-



### Seamless Narrow Flap Hinges

Size	Pcs./Box	Box/Case	Pcs./Case	SATIN Price/Pc.
60x(18x18)x1.7mm	45	16	720	44/-
75x(15x15)x1.7mm	45	16	720	48/-
75x(19x19)x1.7mm	45	12	540	50/-
100x(19x19)x1.7mm	30	12	360	66/-
75x (27x27)x1.7mm	40	12	480	64/-



### Seamless Unequal (Cut) Flap Hinges

Size	Pcs./Box	Box/Case	Pcs./Case	SATIN Price/Pc.
75x(19x13)x1.7mm	45	16	720	44/-
100x(19x13)x1.7mm	40	12	480	58/-
75x(13x25)x1.7mm	45	12	540	54/-
100x(13x25)x1.7mm	40	12	480	70/-
75x (19x25)x1.7mm	45	12	540	60/-
100x (19x25)x1.7mm	30	12	360	78/-
75x (27.5x10)x1.7mm	45	12	540	50/-
60x (27.5x10)x1.7mm	45	16	720	44/-
75x (15x10)x1.7mm	45	16	720	44/-
75x (13x32)x1.7mm	40	12	480	64/-
75x (13x38)x1.7mm	40	12	480	70/-



### Stone Hinges

Size	Pcs./Box	Box/Case	Pcs./Case	SATIN Price/Pc.
100x(25x38)x1.90	15	12	180	130/-



### Stone Double Flap Hinges

Size	Pcs./Box	Box/Case	Pcs./Case	SATIN Price/Pc.
100x(25x38)x1.90	20	12	240	140/-



### Seamless "W" Hinges

Size	Pcs./Box	Box/Case	Pcs./Case	SATIN Price/Pc.
50x(19x6)x1.80	20	12	240	96/-
75x(19x6)x1.80	20	12	240	124/-
75x(19x13)x1.80	20	12	240	136/-
75x(19x19)x1.80	20	12	240	148/-

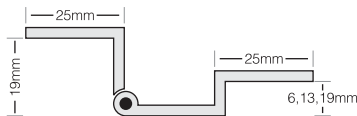

### Seamless "L" Hinges

Size	Pcs./Box	Box/Case	Pcs./Case	SATIN Price/Pc.
75x(10x6)x1.80	30	12	360	72/-
75x(10x13)x1.80	30	12	360	78/-
75x(10x19)x1.80	20	12	240	84/-
75x(13x6)x1.80	30	12	360	84/-
75x(13x13)x1.80	30	12	360	90/-
75x(13x19)x1.80	20	12	240	96/-
100x(13x6)x1.80	25	12	300	114/-
100x(13x13)x1.80	25	12	300	122/-
100x(13x19)x1.80	20	12	240	130/-

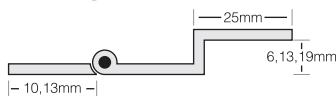

### Section Square Tower-Bolt



Size	Pcs./Box	Box/Case	Pcs./Case	SATIN Price/Pc.
4"x12	10	20	200	216/-
6"x12	5	30	150	312/-
8"x12	5	20	100	416/-
10"x12	5	12	60	520/-
12"x12	5	12	60	624/-
18"x12	5	6	30	936/-
24"x12	5	6	30	1248/-
<hr/>				
4"x10	10	24	240	176/-
6"x10	5	36	180	252/-
8"x10	5	24	120	336/-
10"x10	5	12	60	420/-
12"x10	5	12	60	504/-
18"x10	5	6	30	756/-

### Section Round Tower-Bolt



Size	Pcs./Box	Box/Case	Pcs./Case	SATIN Price/Pc.
4"x12	10	20	200	216/-
6"x12	5	30	150	312/-
8"x12	5	20	100	416/-
10"x12	5	12	60	520/-
12"x12	5	12	60	624/-
18"x12	5	6	30	936/-
24"x12	5	6	30	1248/-
<hr/>				
4"x10	10	24	240	176/-
6"x10	5	36	180	252/-
8"x10	5	24	120	336/-
10"x10	5	12	60	420/-
12"x10	5	12	60	504/-
18"x10	5	6	30	756/-

### Sleek Tower-Bolt



Size	Pcs./Box	Box/Case	Pcs./Case	SATIN Price/Pc.
4"x12	10	20	200	188/-
6"x12	5	30	150	270/-
8"x12	5	20	100	360/-
10"x12	5	12	60	450/-
12"x12	5	12	60	540/-
18"x12	5	6	30	810/-
3"x10	10	24	240	126/-
4"x10	10	24	240	140/-
6"x10	5	24	120	210/-
8"x10	5	12	60	280/-
10"x10	5	12	60	350/-
12"x10	5	6	30	420/-

### Half Round Tower-Bolt



Size	Pcs./Box	Box/Case	Pcs./Case	SATIN Price/Pc.
4"x12	10	20	200	168/-
6"x12	5	30	150	252/-
8"x12	5	20	100	336/-
10"x12	5	12	60	420/-
12"x12	5	12	60	504/-
18"x12	5	6	30	756/-
3"x10	10	24	240	114/-
4"x10	10	24	240	128/-
6"x10	5	24	120	192/-
8"x10	5	12	60	256/-
10"x10	5	12	60	320/-
12"x10	5	6	30	384/-

### Barrel Tower-Bolt



Size	Pcs./Box	Box/Case	Pcs./Case	SATIN Price/Pc.
6"x13	5	24	120	336/-
8"x13	5	18	90	448/-
12"x13	5	12	60	672/-
18"x13	5	6	30	1008/-
24"x13	1	10	10	1344/-
36"x13	1	10	10	2016/-

### Pulsar Tower-Bolt



Size	Pcs./Box	Box/Case	Pcs./Case	SATIN Price/Pc.
4"x12	5	40	200	160/-
6"x12	5	30	150	228/-
8"x12	5	20	100	304/-
10"x12	5	12	60	380/-
12"x12	5	12	60	456/-
3"x10	6	10	240	108/-
4"x10	6	40	240	116/-
6"x10	6	30	180	174/-
8"x10	6	20	120	232/-
10"x10	6	10	60	290/-
12"x10	6	10	60	348/-



### L-Pulsar Tower-Bolt

Size	Pcs./Box	Box/Case	Pcs./Case	SATIN Price/Pc.
4"x10	6	20	120	190/-
6"x10	6	20	120	210/-
8"x10	6	15	90	240/-
12"x10	6	10	60	330/-

**Half Square Tower-Bolt**

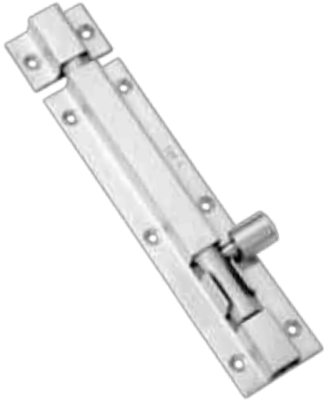

Size	Pcs./Box	Box/Case	Pcs./Case	SATIN Price/Pc.
4"x12	10	20	200	160/-
6"x12	5	30	150	240/-
8"x12	5	20	100	320/-
10"x12	5	15	75	400/-
12"x12	5	12	60	480/-
18"x12	5	8	40	720/-
4"x10	10	24	240	120/-
6"x10	5	36	180	180/-
8"x10	5	24	120	240/-
10"x10	5	18	90	300/-
12"x10	5	18	90	360/-

**Half Square Tower-Bolt One Pc**



Size	Pcs./Box	Box/Case	Pcs./Case	SATIN Price/Pc.
4"x12	5	40	200	140/-
6"x12	5	30	150	192/-
8"x12	5	20	100	256/-
10"x12	5	15	75	320/-
12"x12	5	12	60	384/-
4"x10	6	40	240	92/-
6"x10	6	30	180	138/-
8"x10	6	20	120	184/-
10"x10	5	18	90	230/-

**Half Round Tower-Bolt One Pc**

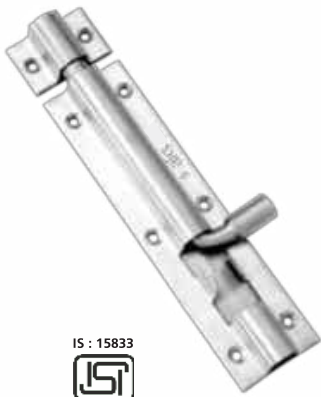

Size	Pcs./Box	Box/Case	Pcs./Case	SATIN Price/Pc.
4"x12	5	40	200	140/-
6"x12	5	30	150	192/-
8"x12	5	20	100	256/-
10"x12	5	15	75	320/-
12"x12	5	12	60	384/-
4"x10	6	40	240	92/-
6"x10	6	30	180	138/-
8"x10	6	20	120	184/-
10"x10	5	18	90	230/-
3"x9	6	40	240	84/-
4"x9	6	40	240	88/-
6"x9	6	30	180	132/-
8"x9	6	20	120	176/-
3"x7	12	40	480	60/-
4"x7	10	40	400	66/-



### Duster Baby Latch

Size	Pcs./Box	Box/Case	Pcs./Case	TT Price/Pc.
4"	10	12	120	240/-
5"	10	12	120	270/-



### Square Baby Latch

Size	Pcs./Box	Box/Case	Pcs./Case	Satin Price/Pc.
3"	10	18	180	120/-



### Sleek Baby Latch

Size	Pcs./Box	Box/Case	Pcs./Case	TT Price/Pc.
3"	10	18	180	140/-

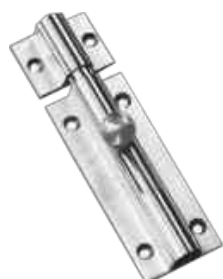

### Round Baby Latch

Size	Pcs./Box	Box/Case	Pcs./Case	Satin Price/Pc.
3"	10	18	180	124/-



### Section Square Door Stopper (Double Rod)

Size	Pcs./Box	Box/Case	Pcs./Case	TT Price/Pc.
4"x12mm	8	15	120	270/-



### Section Square Door Stopper (Single Rod)

Size	Pcs./Box	Box/Case	Pcs./Case	TT Price/Pc.
4"x12mm	10	12	120	170/-
5"x14mm	8	15	120	240/-

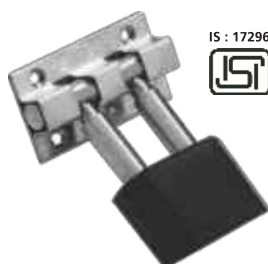

IS : 17296



### Half Square/Round Door Stopper (Double Rod)

Size	Pcs./Box	Box/Case	Pcs./Case	TT Price/Pc.
3"x10mm	8	15	120	160/-



### Door Silencer

Size	Pcs./Box	Box/Case	Pcs./Case	TT Price/Pc.
3"	10	12	120	120/-

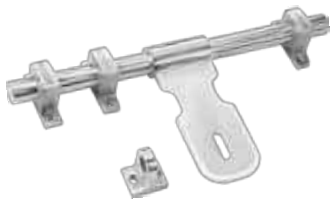

Extra Nuckle for ₹ 145/- Each  
Extra Kunda for ₹ 95/- Each

### Lamont Al-Drop

Size	Pcs./Box	Box/Case	Pcs./Case	TT Price/Pc.
12"x19mm(3+1)	1	10	10	1260/-
14"x19mm(3+1)	1	10	10	1320/-
16"x19mm(4+1)	1	10	10	1500/-
18"x19mm(4+1)	1	10	10	1560/-



Extra Nuckle for ₹ 95/- Each  
Extra Kunda for ₹ 75/- Each

### Combo Sleek Al-Drop

Size	Pcs./Box	Box/Case	Pcs./Case	TT Price/Pc.
8"x16mm(2+1)	1	30	30	680/-
10"x16mm(3+1)	1	30	30	770/-
12"x16mm(3+1)	1	30	30	820/-
14"x16mm(4+1)	1	30	30	940/-



Extra Nuckle for ₹ 95/- Each  
Extra Kunda for ₹ 75/- Each

### Creta Al-Drop

Size	Pcs./Box	Box/Case	Pcs./Case	TT Price/Pc.
8"x16mm(2+1)	1	30	30	660/-
10"x16mm(3+1)	1	30	30	780/-
12"x16mm(3+1)	1	30	30	830/-
14"x16mm(4+1)	1	30	30	950/-



Extra Nuckle for ₹ 95/- Each  
Extra Kunda for ₹ 75/- Each

### Auro Al-Drop

Size	Pcs./Box	Box/Case	Pcs./Case	TT Price/Pc.
8"x16mm(2+1)	1	30	30	680/-
10"x16mm(3+1)	1	30	30	770/-
12"x16mm(3+1)	1	30	30	820/-

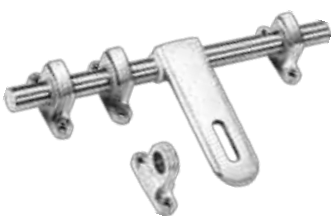

Extra Nuckle for ₹ 95/- Each  
Extra Kunda for ₹ 75/- Each

### Casting Straight Al-Drop

Size	Pcs./Box	Box/Case	Pcs./Case	TT Price/Pc.
8"x16mm(2+1)	1	30	30	720/-
10"x16mm(3+1)	1	30	30	810/-
12"x16mm(3+1)	1	30	30	860/-



Extra Nuckle for ₹ 145/- Each  
Extra Kunda for ₹ 120/- Each

### Solid Straight Al-Drop

Size	Pcs./Box	Box/Case	Pcs./Case	TT Price/Pc.
10"x16mm(2+1)	1	30	30	850/-
12"x16mm(2+1)	1	20	20	990/-
14"x16mm(2+1)	1	20	20	1040/-
16"x16mm(2+1)	1	20	20	1200/-



Extra Nuckle for ₹ 85/- Each  
Extra Kunda for ₹ 120/- Each

### Royal Al-Drop

Size	Pcs./Box	Box/Case	Pcs./Case	TT Price/Pc.
8"x16mm(2+1)	1	30	30	660/-
10"x16mm(3+1)	1	30	30	750/-
12"x16mm(3+1)	1	30	30	800/-



**For 16mm**  
Extra Nuckle for ₹ 70/- Each  
Extra Kunda for ₹ 120/- Each

**For 14mm**  
Extra Nuckle for ₹ 50/- Each  
Extra Kunda for ₹ 120/- Each

### Sleek Al-Drop

Size	Pcs./Box	Box/Case	Pcs./Case	TT Price/Pc.
8"x16mm(2+1)	1	30	30	560/-
10"x16mm(3+1)	1	30	30	640/-
12"x16mm(3+1)	1	30	30	690/-
14"x16mm(4+1)	1	20	20	810/-
8"x14mm(2+1)	4	10	40	430/-
10"x14mm(3+1)	4	10	40	480/-
12"x14mm(3+1)	4	10	40	520/-



**For 14mm**  
Extra Nuckle for ₹ 50/- Each  
Extra Kunda for ₹ 60/- Each

**For 12mm**  
Extra Nuckle for ₹ 40/- Each  
Extra Kunda for ₹ 60/- Each

### Dotted Al-Drop

Size	Pcs./Box	Box/Case	Pcs./Case	SATIN Price/Pc.
8"x14mm(2+1)	6	10	60	340/-
10"x14mm(2+1)	6	10	60	390/-
12"x14mm(2+1)	6	10	60	420/-
6"x12mm(2+1)	6	10	60	260/-
8"x12mm(2+1)	6	10	60	280/-
10"x12mm(3+1)	6	10	60	320/-



Extra Nuckle for ₹ 60/- Each  
Extra Kunda for ₹ 120/- Each

### Duster Al-Drop

Size	Pcs./Box	Box/Case	Pcs./Case	TT Price/Pc.
8"x14mm(2+1)	4	10	40	420/-
10"x14mm(3+1)	4	10	40	470/-
12"x14mm(3+1)	4	10	40	510/-

### Straight Al-Drop

Size	Pcs./Box	Box/Case	Pcs./Case	SATIN Price/Pc.
8"x16mm(2+1)	4	10	40	460/-
10"x16mm(3+1)	4	10	40	510/-
12"x16mm(3+1)	4	10	40	560/-
14"x16mm(4+1)	4	5	20	680/-
8"x14mm(2+1)	4	10	40	340/-
10"x14mm(3+1)	4	10	40	390/-
12"x14mm(3+1)	4	10	40	420/-
6"x12mm(2+1)	6	10	60	260/-
8"x12mm(2+1)	6	10	60	280/-
10"x12mm(3+1)	6	10	60	320/-



### Bend Al-Drop

Size	Pcs./Box	Box/Case	Pcs./Case	SATIN Price/Pc.
8"x16mm(2+1)	4	10	40	460/-
10"x16mm(3+1)	4	10	40	510/-
12"x16mm(3+1)	4	10	40	560/-
14"x16mm(4+1)	4	5	20	680/-
8"x14mm(2+1)	4	10	40	340/-
10"x14mm(3+1)	4	10	40	390/-
12"x14mm(3+1)	4	10	40	420/-
6"x12mm(2+1)	6	10	60	420/-
8"x12mm(2+1)	6	10	60	420/-
10"x12mm(3+1)	6	10	60	420/-



IS : 15834

**Sleek Combo Latch**



Size	Pcs./Box	Box/Case	Pcs./Case	TT Price/Pc.
8"x12mm	2	30	60	340/-
10"x12mm	2	30	60	360/-
12"x12mm	2	30	60	380/-

**Duster Latch**



Size	Pcs./Box	Box/Case	Pcs./Case	TT Price/Pc.
8"x12mm	4	20	80	260/-
10"x12mm	4	15	60	270/-
12"x12mm	4	15	60	280/-

**Sleek Latch**



Size	Pcs./Box	Box/Case	Pcs./Case	TT Price/Pc.
8"x12mm	4	20	80	260/-
10"x12mm	4	15	60	270/-
12"x12mm	4	15	60	280/-

**Straight Latch**



Size	Pcs./Box	Box/Case	Pcs./Case	TT Price/Pc.
6"x12mm	4	20	80	230/-
8"x12mm	4	20	80	240/-
10"x12mm	4	15	60	250/-
12"x12mm	4	15	60	265/-

### Casting Sleek



Size	Pcs./Box	Box/Case	Pcs./Case	TT Price/Pc.
8" (150x198)	1	40	40	540/-
10" (200x248)	1	40	40	600/-
12" (250x298)	1	40	40	660/-

### Etios



Size	Pcs./Box	Box/Case	Pcs./Case	TT Price/Pc.
8" (150x198)	1	40	40	570/-
10" (200x248)	1	40	40	620/-
12" (250x298)	1	40	40	670/-

### Gema



Size	Pcs./Box	Box/Case	Pcs./Case	TT Price/Pc.
8" (150x198)	1	40	40	450/-
10" (200x248)	1	40	40	500/-
12" (250x298)	1	40	40	550/-

### Full Square Plate Handle



Size	Pcs./Box	Box/Case	Pcs./Case	TT Price/Pc.
6"x12mm	12	10	120	230/-
8"x12mm	12	10	120	260/-

### Full Round Plate Handle



Size	Pcs./Box	Box/Case	Pcs./Case	SATIN Price/Pc.
6"x12mm	12	10	120	170/-
8"x12mm	12	10	120	190/-



### Moon Handle

Size	Pcs./Box	Box/Case	Pcs./Case	SATIN Price/Pc.
6"x12mm	12	10	120	160/-
8"x12mm	12	10	120	170/-



### Sleek Handle

Size	Pcs./Box	Box/Case	Pcs./Case	TT Price/Pc.
8"x4mm	6	20	120	200/-
10"x4mm	6	15	90	250/-



### Royal Handle

Size	Pcs./Box	Box/Case	Pcs./Case	TT Price/Pc.
6"x4mm	12	10	120	150/-
8"x4mm	12	10	120	180/-



### Kwid Handle

Size	Pcs./Box	Box/Case	Pcs./Case	TT Price/Pc.
6"x4mm	12	10	120	180/-
8"x4mm	12	10	120	210/-

### Bentley Handle



Size	Pcs./Box	Box/Case	Pcs./Case	TT Price/Pc.
5"x4mm	12	15	180	180/-
6"x4mm	12	10	120	200/-
8"x4mm	12	10	120	230/-

### Kwid Handle



Size	Pcs./Box	Box/Case	Pcs./Case	TT Price/Pc.
4"x3mm	20	16	320	84/-
5"x3mm	20	16	320	90/-
6"x3mm	20	16	320	112/-

### A-One Handle



Size	Pcs./Box	Box/Case	Pcs./Case	TT Price/Pc.
5"x3mm	20	16	320	78/-
6"x3mm	20	16	320	90/-

### A-Two Handle



Size	Pcs./Box	Box/Case	Pcs./Case	TT Price/Pc.
5"x4mm	16	10	160	120/-
6"x4mm	12	10	120	140/-
8"x4mm	12	10	120	170/-



### Sleek Handle

Size	Pcs./Box	Box/Case	Pcs./Case	TT Price/Pc.
5"x3mm	20	16	320	92/-
7"x3mm	20	16	320	104/-



### Duster Handle

Size	Pcs./Box	Box/Case	Pcs./Case	TT Price/Pc.
5"x3mm	20	16	320	92/-
6"x3mm	20	16	320	100/-



### Palki Handle

Size	Pcs./Box	Box/Case	Pcs./Case	TT Price/Pc.
4"x3mm	20	16	320	84/-
5"x3mm	20	16	320	92/-
6"x3mm	20	16	320	100/-



### "D" Plain Handle (Straight)

Size	Pcs./Box	Box/Case	Pcs./Case	TT Price/Pc.
4"x2.5mm	20	16	320	48/-
5"x2.5mm	20	16	320	54/-
6"x2.5mm	20	16	320	60/-
5"x3.0mm	20	16	320	60/-
6"x3.0mm	20	16	320	72/-



**Code** : DC063T

**Price** : 1860/-

### Specification

Door Weight : 45-65 Kgs  
 Door Width : 800-1100mm  
 Product Dimensions : 218x52x44mm  
 Hole Distance : 201mmx19mm  
 Adj. Latching Speed : Yes  
 Adj. Closing Speed : Yes  
 Back check : No  
 Non-Hold Open : Yes  
 Hold Open : No  
 Life Cycles : 3000000  
 Power Size : EN 2

- High Quality die-casting aluminium alloy Protected with two-layer bright paint.
- Two hydraulic press values controlling two stage doors closing speed automatically, 180° fully hydraulic control
- Two stage speed adjustable, maximum opening degree is 180°
- Can be installed on right and left opening doors, no need to refit
- Standard color - silver



**Code** : DC080R

**Price** : 2760/-

### Specification

Door Weight : 45-65 Kgs  
 Door Width : 1100-2100mm  
 Product Dimensions : 230x59x32mm  
 Adj. Latching Speed : Yes  
 Adj. Closing Speed : Yes  
 Back check : No  
 Non-Hold Open : Yes  
 Hold Open : Yes  
 Life Cycles : 3000000  
 Power Size : EN 2  
 Arm : Pelmet

- High Quality die-casting aluminium alloy Protected with two-layer bright paint.
- Two hydraulic press values controlling two stage doors closing speed automatically, 180° fully hydraulic control
- Two stage speed adjustable, maximum opening degree is 180°
- Can be installed on right and left opening doors, no need to refit
- Standard color - silver



**Code** : DC160A

**Price** : 2700/-

### Specification

Door Weight : 30-80 Kgs  
 Door Width : 500-1100mm  
 Product Dimensions : 206x55x40mm  
 Hole Distance : 104x139mm  
 Adj. Latching Speed : Yes  
 Adj. Closing Speed : Yes  
 Back check : No  
 Non-Hold Open : Yes  
 Hold Open : Yes  
 Life Cycles : 3000000  
 power Size : EN 2  
 Arm : Pelmet

- High Quality die-casting aluminium alloy Protected with two-layer bright paint.
- Two hydraulic press values controlling two stage doors closing speed automatically, 180° fully hydraulic control
- Two stage speed adjustable, maximum opening degree is 180°
- Can be installed on right and left opening doors, no need to refit
- Standard color - silver



**Code** : DC051S

**Price** : 1260/-

**Specification**

Door Weight : 25-45 Kgs  
 Door Width : 500-1000mm  
 Product Dimensions : 148x38x55mm  
 Hole Distance : 132x19mm  
 Adj. Latching Speed : Yes  
 Adj. Closing Speed : Yes  
 Back check : No  
 Non-Hold Open : Yes  
 Hold Open : No  
 Life Cycles : 3000000  
 Power Size : EN 2

- High Quality die-casting aluminium alloy Protected with two-layer bright paint.
- Two hydraulic press values controlling two stage doors closing speed automatically, 180° fully hydraulic control
- Two stage speed adjustable, maximum opening degree is 180°
- Can be installed on right and left opening doors, no need to refit
- Standard color - silver



CE EN1154

**Code** : DC061S

**Price** : 1500/-

**Specification**

Door Weight : 45-65 Kgs  
 Door Width : 600-1200mm  
 Product Dimensions : 178x40x65mm  
 Hole Distance : 162x19mm  
 Adj. Latching Speed : Yes  
 Adj. Closing Speed : Yes  
 Back check : No  
 Non-Hold Open : Yes  
 Hold Open : Yes  
 Life Cycles : 5000000  
 Power Size : EN 3  
 Arm : Pelmet

- High Quality die-casting aluminium alloy Protected with two-layer bright paint.
- Two hydraulic press values controlling two stage doors closing speed automatically, 180° fully hydraulic control
- Two stage speed adjustable, maximum opening degree is 180°
- Can be installed on right and left opening doors, no need to refit
- Standard color - silver



**Code** : DC1602S

**Price** : 1800/-

**Specification**

Door Weight : 60-80 Kgs  
 Door Width : 900-1300mm  
 Product Dimensions : 202x44x68mm  
 Hole Distance : 188x19mm  
 Adj. Latching Speed : Yes  
 Adj. Closing Speed : Yes  
 Back check : No  
 Non-Hold Open : Yes  
 Hold Open : Yes  
 Life Cycles : 3000000  
 power Size : EN 4  
 Arm : Pelmet

- High Quality die-casting aluminium alloy Protected with two-layer bright paint.
- Two hydraulic press values controlling two stage doors closing speed automatically, 180° fully hydraulic control
- Two stage speed adjustable, maximum opening degree is 180°
- Can be installed on right and left opening doors, no need to refit
- Standard color - silver



**Code** : ADC-82

**Price** : 1170/-

### Specification

- Applicable to single door with the maximum door width of 1000mm.
- Precise sealed, preventing oil leakage, useful time is more than 500,000 times.
- High quality die-casting aluminium alloy, protected with two-layer bright paint.
- Two hydraulic press valves controlling two stage doors closing speed automatically 180° fully hydraulic control.
- Two stage speed adjustable, maximum opening degree is 180°
- Can be installed on right and left opening doors, no need to refit.
- Suitable for the door weight of 40-65 kg
- Standard color: Silver



**Code** : ADC-84

**Price** : 1200/-

### Specification

- Applicable to single door with the maximum door width of 1200mm.
- Precise sealed, preventing oil leakage, useful time is more than 500,000 times.
- High quality die-casting aluminium alloy, protected with two-layer bright paint.
- Two hydraulic press valves controlling two stage doors closing speed automatically 180° fully hydraulic control.
- Two stage speed adjustable, maximum opening degree is 180°
- Can be installed on right and left opening doors, no need to refit.
- Suitable for the door weight of 40-65 kg
- Standard color: Silver



**Code** : ADC-83

**Price** : 1500/-

### Specification

- Applicable to single door with the maximum door width of 1000mm.
- Precise sealed, preventing oil leakage, useful time is more than 500,000 times.
- High quality die-casting aluminium alloy, protected with two-layer bright paint.
- Two hydraulic press valves controlling two stage doors closing speed automatically 180° fully hydraulic control.
- Two stage speed adjustable, maximum opening degree is 180°
- Can be installed on right and left opening doors, no need to refit.
- Suitable for the door weight of 60-85 kg
- Standard color: Silver

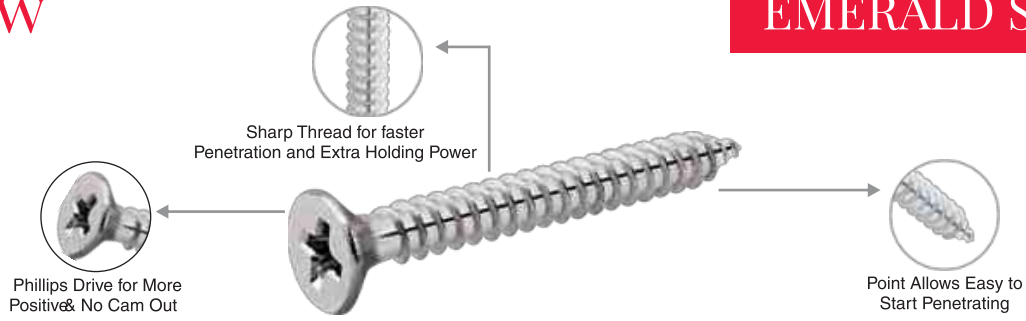

**CSK & PAN Phillips Head Self Tapping Screws**

Size	Pcs/Box	Box/Case	CSK Phillips Price/100 pcs	PAN Phillips Price/100 pcs	Size	Pcs/Box	Box/Case	CSK Phillips Price/100 pcs	PAN Phillips Price/100 pcs
4x13	200x10	18	64/-	70/-	8x35	100x5	18	220/-	246/-
4x16	200x10	18	70/-	78/-	8x38	100x5	18	230/-	260/-
4x19	200x10	18	78/-	82/-	8x45	100x5	18	250/-	252/-
4x25	200x5	18	82/-	88/-	8x50	100x5	18	284/-	306/-
5x13	200x10	18	74/-	78/-	8x60	50x5	18	422/-	464/-
5x16	200x10	18	82/-	90/-	8x75	50x5	18	650/-	710/-
5x19	200x5	18	92/-	104/-	10x19	100x5	18	222/-	244/-
5x25	200x5	18	108/-	122/-	10x25	100x5	18	240/-	266/-
6x13	200x5	18	76/-	84/-	10x32	100x5	18	270/-	294/-
6x16	200x5	18	86/-	94/-	10x38	100x5	18	294/-	334/-
6x19	200x5	18	94/-	104/-	10x50	50x5	18	378/-	426/-
6x25	200x5	18	130/-	136/-	10x60	50x5	18	756/-	826/-
6x32	100x5	18	148/-	158/-	10x75	50x5	18	1240/-	1364/-
6x38	100x5	18	184/-	208/-	10x100	200x1	18	1528/-	1680/-
6x50	100x5	18	264/-	290/-	10x125	150x1	18	302/-	324/-
6x60	100x5	18	264/-	290/-	12x50	200x1	18	448/-	492/-
7x19	200x5	18	152/-	170/-	12x60	200x1	18	828/-	910/-
7x25	200x5	18	152/-	170/-	12x75	200x1	18	1340/-	1474/-
7x30	100x5	18	184/-	216/-	12x100	150x1	18	2010/-	2212/-
7x35	100x5	18	200/-	220/-	12x125	125x1	18	3016/-	3316/-
8x13	200x5	18	128/-	140/-	12x150	100x1	18	3980/-	4378/-
8x16	200x5	18	132/-	58/-	14x100	100x1	18	2206/-	2426/-
8x19	200x5	18	144/-	166/-	14x125	100x1	18	3206/-	3526/-
8x25	200x5	18	166/-	190/-	14x150	100x1	18	4052/-	4458/-
8x32	100x5	18	200/-	232/-					

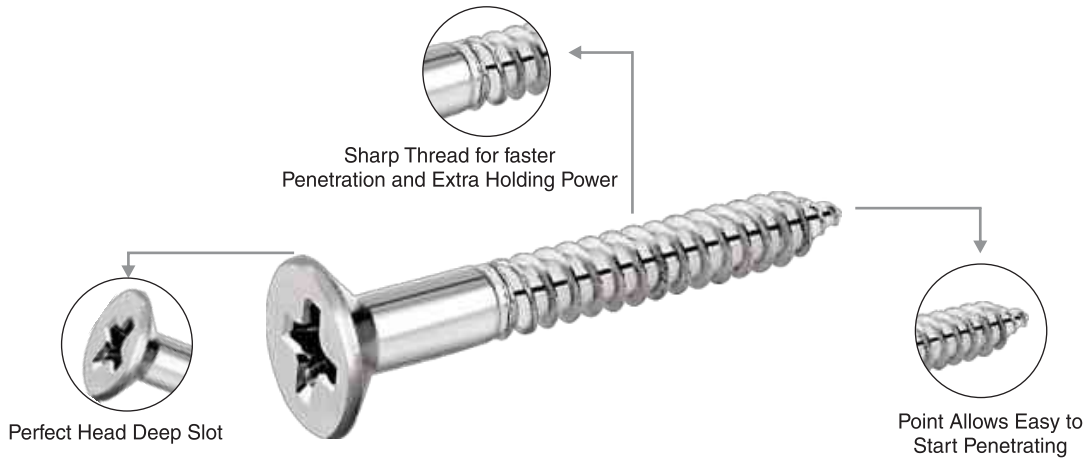

## CSK Phillips Head Self Tapping Wood Screws

Size	Pcs./Box	Box./Case	Price/100 pcs	Size	Pcs./Box	Box./Case	Price/100 pcs
12x4	200x10	18	70/-	60x8	100x5	18	608/-
15x4	200x10	18	78/-	75x8	100x5	18	964/-
20x4	200x10	18	82/-	25x10	100x5	18	266/-
25x4	200x10	18	88/-	50x10	50x5	18	426/-
15x5	200x10	18	90/-	60x10	50x5	18	822/-
20x5	200x5	18	102/-	75x10	50x5	18	1346/-
25x5	200x5	18	120/-	100x10	40x5	18	1760/-
20x6	200x5	18	104/-	50x12	200x1	18	510/-
25x6	200x5	18	136/-	60x12	200x1	18	914/-
20x7	200x5	18	146/-	75x12	200x1	18	1456/-
25x7	200x5	18	166/-	100x12	150x1	18	2226/-
30x7	100x5	18	200/-	125x12	150x1	18	3344/-
35x7	100x5	18	230/-	150x12	100x1	18	4537/-
20x8	200x5	18	152/-	100x14	100x1	18	2462/-
25x8	200x5	18	152/-	125x14	100x1	18	3878/-
30x8	100x5	18	220/-	150x14	100x1	18	4892/-
35x8	100x5	18	236/-				
40x8	100x5	18	276/-				
45x8	100x5	18	298/-				
50x8	100x5	18	312/-				

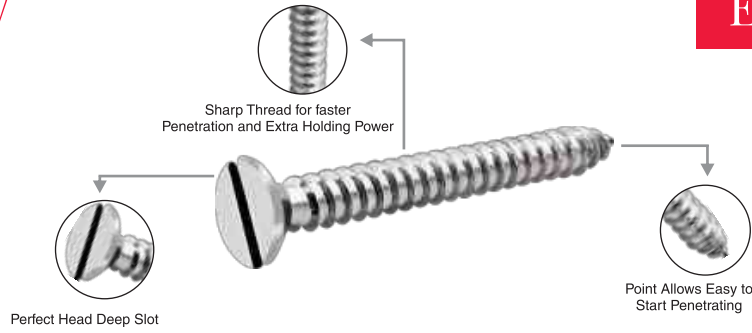

## CSK & PAN Slotted Head Self Tapping Screws

Size	Pcs/ Box	Box/ Case	CSK Phillips Price/100 pcs	PAN Phillips Price/100 pcs	Size	Pcs/ Box	Box/ Case	CSK Phillips Price/100 pcs	PAN Phillips Price/100 pcs
4x13	200x10	18	44/-	50/-	8x35	100x5	18	142/-	158/-
4x16	200x10	18	48/-	54/-	8x38	100x5	18	152/-	172/-
4x19	200x10	18	52/-	58/-	8x45	100x5	18	170/-	192/-
4x25	200x5	18	58/-	66/-	8x50	100x5	18	192/-	216/-
5x13	200x10	18	52/-	58/-	8x60	50x5	18	366/-	410/-
5x16	200x10	18	56/-	62/-	8x75	50x5	18	574/-	644/-
5x19	200x5	18	58/-	66/-	10x25	100x5	18	166/-	186/-
5x25	200x5	18	76/-	86/-	10x32	100x5	18	188/-	212/-
6x13	200x5	18	52/-	58/-	10x38	100x5	18	206/-	230/-
6x16	200x5	18	58/-	64/-	10x50	50x5	18	256/-	286/-
6x19	200x5	18	60/-	68/-	10x60	50x5	18	502/-	562/-
6x25	200x5	18	80/-	92/-	10x75	50x5	18	802/-	898/-
6x32	100x5	18	102/-	114/-	10x100	125x1	18	990/-	1108/-
6x38	100x5	18	124/-	142/-	10x125	150x1	18	166/-	186/-
6x50	100x5	18	176/-	194/-	12x50	200x1	18	298/-	334/-
6x60	100x5	18	322/-	360/-	12x60	200x1	18	552/-	618/-
7x19	200x5	18	82/-	96/-	12x75	200x1	18	888/-	994/-
7x25	200x5	18	104/-	116/-	12x100	150	18	1330/-	1488/-
7x30	100x5	18	122/-	136/-	12x125	150	18	1992/-	2190/-
7x35	100x5	18	134/-	150/-	12x150	150	18	2654/-	2918/-
8x13	200x5	18	84/-	92/-	14x38	40x5	18	360/-	400/-
8x16	200x5	18	92/-	102/-	14x100	100	18	1496/-	1650/-
8x19	200x5	18	98/-	110/-	14x125	100	18	2356/-	2560/-
8x25	200x5	18	108/-	122/-	14x150	100	18	2988/-	3252/-
8x32	100x5	18	132/-	148/-					

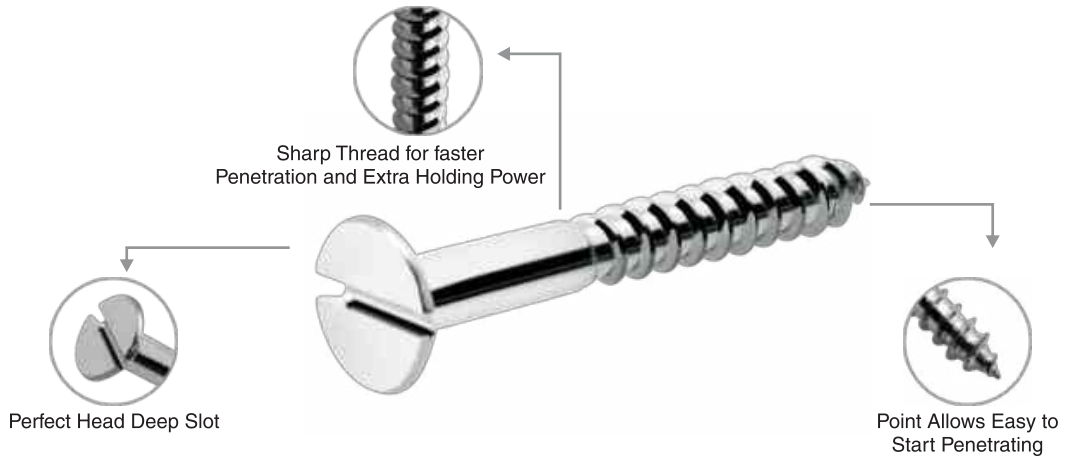

**CSK Slotted Head Self Tapping Wood Screws**

Size	Pcs./Box	Box./Case	Price/100 pcs	Size	Pcs./Box	Box./Case	Price/100 pcs
12x4	200x10	18	54/-	40x8	100x5	18	184/-
15x4	200x10	18	58/-	45x8	100x5	18	198/-
20x4	200x10	18	62/-	50x8	100x5	18	216/-
25x4	200x10	18	66/-	60x8	100x5	18	406/-
12x5	200x10	18	62/-	75x8	50x5	18	642/-
15x5	200x10	18	64/-	25x10	100x5	18	190/-
15x6	200x10	18	70/-	50x10	50x5	18	294/-
20x5	200x5	18	70/-	60x10	50x5	18	548/-
25x5	200x5	18	84/-	75x10	50x5	18	898/-
20x6	200x5	18	72/-	100x10	40x5	18	1174/-
25x6	200x5	18	96/-				
30x6	200x5	18	122/-				
20x7	200x5	18	98/-				
25x7	200x5	18	120/-				
30x7	100x5	18	140/-				
35x7	100x5	18	158/-				
20x8	200x5	18	112/-				
25x8	200x5	18	126/-				
30x8	100x5	18	152/-				
35x8	100x5	18	164/-				



**Carriage Bolt**

Size	Pcs./Box	Box./Case	Price/100 pcs
38mm	40x5	18	606/-
45mm	40x5	18	634/-
50mm	40x5	18	660/-



### Docoss Cloth Hook

Size	Pcs/Case	TT Price/Pc.
1 STUD	240	120/-
2 STUD	180	210/-
3 STUD	120	260/-
4 STUD	90	310/-
5 STUD	90	360/-
6 STUD	90	410/-



### Square Gate Hook

Size	Pcs./Box	Box/Case	Pcs/Case	TT Price/Pc.
2"x4mm	40	30	1200	52/-
2.5"x4mm	40	30	1200	53/-
4"x6mm	15	16	240	70/-
5"x6mm	15	16	240	72/-
6"x6mm	15	16	240	75/-
8"x6mm	15	12	180	81/-



### Round Gate Hook

Size	Pcs./Box	Box/Case	Pcs/Case	TT Price/Pc.
2"x4mm	40	30	1200	38/-
2.5"x4mm	40	30	1200	40/-
4"x6mm	15	16	240	63/-
5"x6mm	15	16	240	66/-
6"x6mm	15	16	240	68/-
8"x6mm	15	12	180	75/-

# FINISH



» Matt Satin Lacquered



» Matt Antique Brass

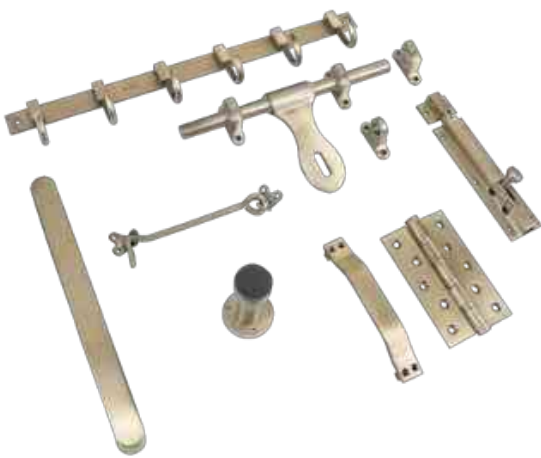

» Antique Brass



» Matt Black



» Scotch Brite Rose Gold





**Steel Paradise (India) Pvt. Ltd.**

Corp. Office : C-93, Sec-3, DSIDC,  
Bawana Indl. Estate, Delhi-110 039  
T. 97182 93000 | E. info@akssteel.com  
www.akssteel.com

 akssteelindia  steelhardwares  company/akssteelindia